

Pressed reducer with gasket | male ends

RPCL



Description

The RPCL reducers have male ends which slip into spiral ducts or plain ducts. The ends feature double EPDM gaskets to ensure the highest class of air tightness. This reducer helps to save installation space, but it increases the flow resistance compared to RSCLL long reducers. Standard nominal diameters up to DN 315 mm are available for pressed pieces at a lower price and with an improved finish.

Available materials — Product code example

RPCL-...-... – galvanized steel sheet

Product code example

Product code: **RPCL - aaa - bbb**

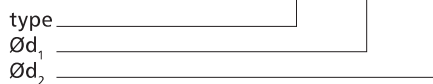

Dimensions

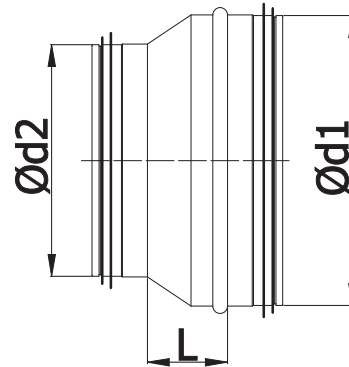

$\varnothing d_{1\text{ nom}}$ (mm)	$\varnothing d_{2\text{ nom}}$ (mm)	L (mm)	Weight (kg)
100	80	18	0.20
125	80	28	0.20
	100	22	0.20
140	100*	30	0.20
	125	30	0.20
150	100	35	0.20
	125	30	0.20
	140	30	0.20
160	80	48	0.30
	100	37	0.30
	125	26	0.20
	140	30	0.30
	150	30	0.30
	160	30	0.30
180	125*	40	0.30
	140*	30	0.30
	150*	30	0.30
	160	30	0.30
200	100	58	0.40
	125	46	0.40
	140*	40	0.30
	150	35	0.30
	160	26	0.30
	180	30	0.30
224	150*	50	0.40
	160*	50	0.40
	180*	30	0.40
	200	30	0.40

Pressed reducer with gasket | male ends

RPCL

Dimensions

$\varnothing d_{1\text{ nom}}$ (mm)	$\varnothing d_{2\text{ nom}}$ (mm)	L (mm)	Weight (kg)
250	125	70	0.50
	150	60	0.50
	160	53	0.50
	180*	50	0.40
	200	31	0.60
	224*	50	0.50
280	160*	80	0.60
	180*	70	0.60
	200*	60	0.60
	224*	40	0.60
	250*	30	0.50
300	200*	70	0.70
	224*	60	0.70
	250*	30	0.60
	280*	30	0.70
315	160	88	0.80
	180*	90	0.80
	200	68	0.70
	224*	60	0.70
	250	43	0.70
	280*	40	0.70
	300*	38	0.70
	355	200*	110
355	224*	90	1.00
	250*	70	1.00
	315*	30	0.90
	400	200*	140
400	224*	120	1.40
	250*	100	1.30
	315*	60	1.30
	355*	30	1.20
	450	250*	140
280*		110	1.90
300*		100	1.90
315*		90	1.80
355*		60	1.70
400*		40	1.70
500		250*	128
	300*	140	2.40
	315*	120	2.20
	355*	100	2.20
	400*	70	2.10
	450*	40	2.10

$\varnothing d_{1\text{ nom}}$ (mm)	$\varnothing d_{2\text{ nom}}$ (mm)	L (mm)	Weight (kg)
560	315*	170	2.90
	355*	140	2.80
	400*	110	2.70
	450*	80	2.60
	500*	75	2.60
600	400*	130	3.10
	450*	100	3.00
	500*	70	2.70
630	560*	30	2.40
	315*	160	3.20
	400*	140	3.30
	450*	120	3.30
	500*	80	3.00
	560*	75	2.90
600*	30	2.50	

*Segmented versions; other versions are pressed only.

Ventilation duct reducers

RPCL/RPCFL/RPC/RPCF

Technical specifications

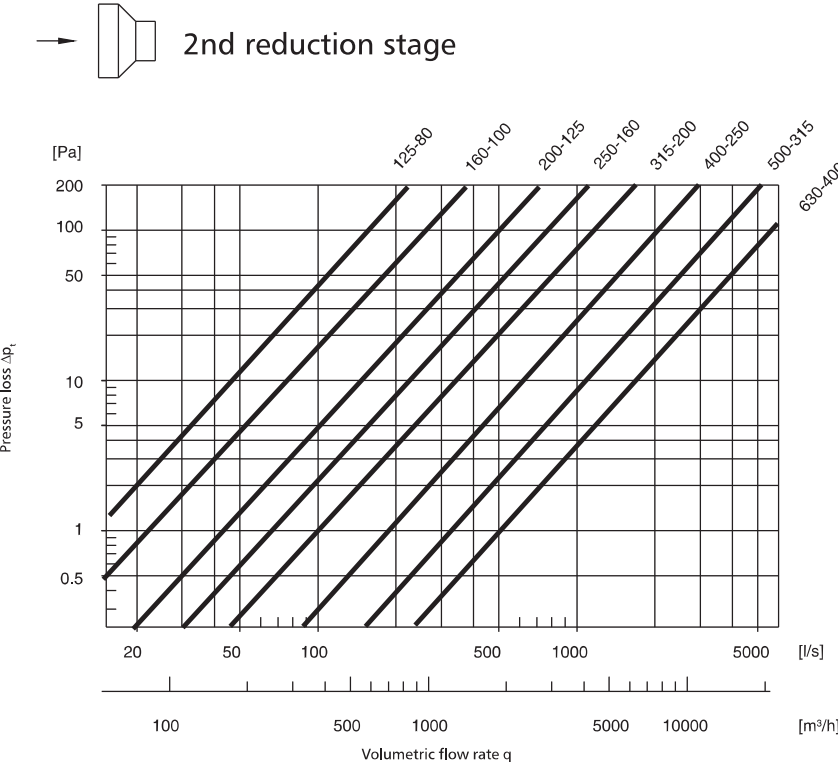
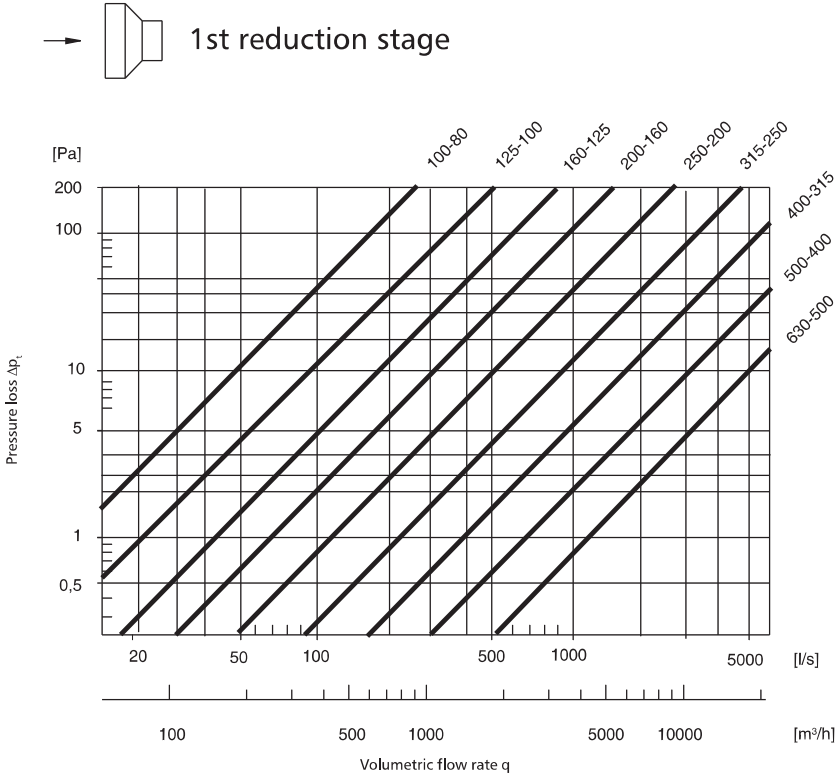

Ventilation duct reducers

RPCL/RPCFL/RPC/RPCF

Technical specifications

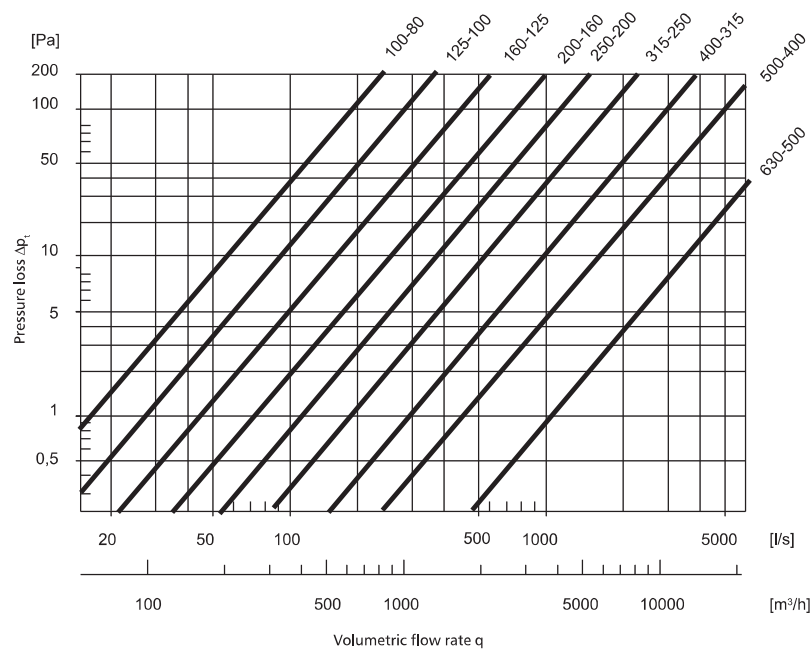
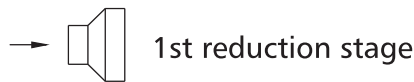
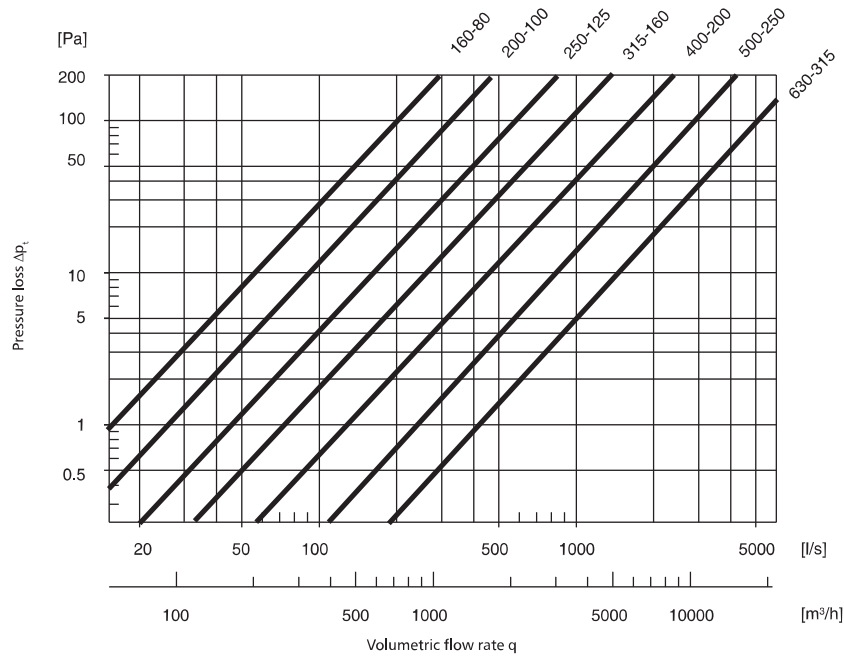
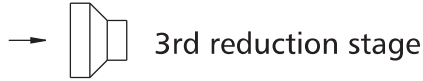

RPCL/RPCFL/RPC/RPCF

Technical specifications

